

Virtual Gym

Disciplina: Análise e Projeto de Sistemas

Professor: Augusto Sampaio

Equipe:

Dyego Penha

Matheus Dornelas

Vinícius Folha

Vinicius Carneiro

Projeto de Caso de Uso

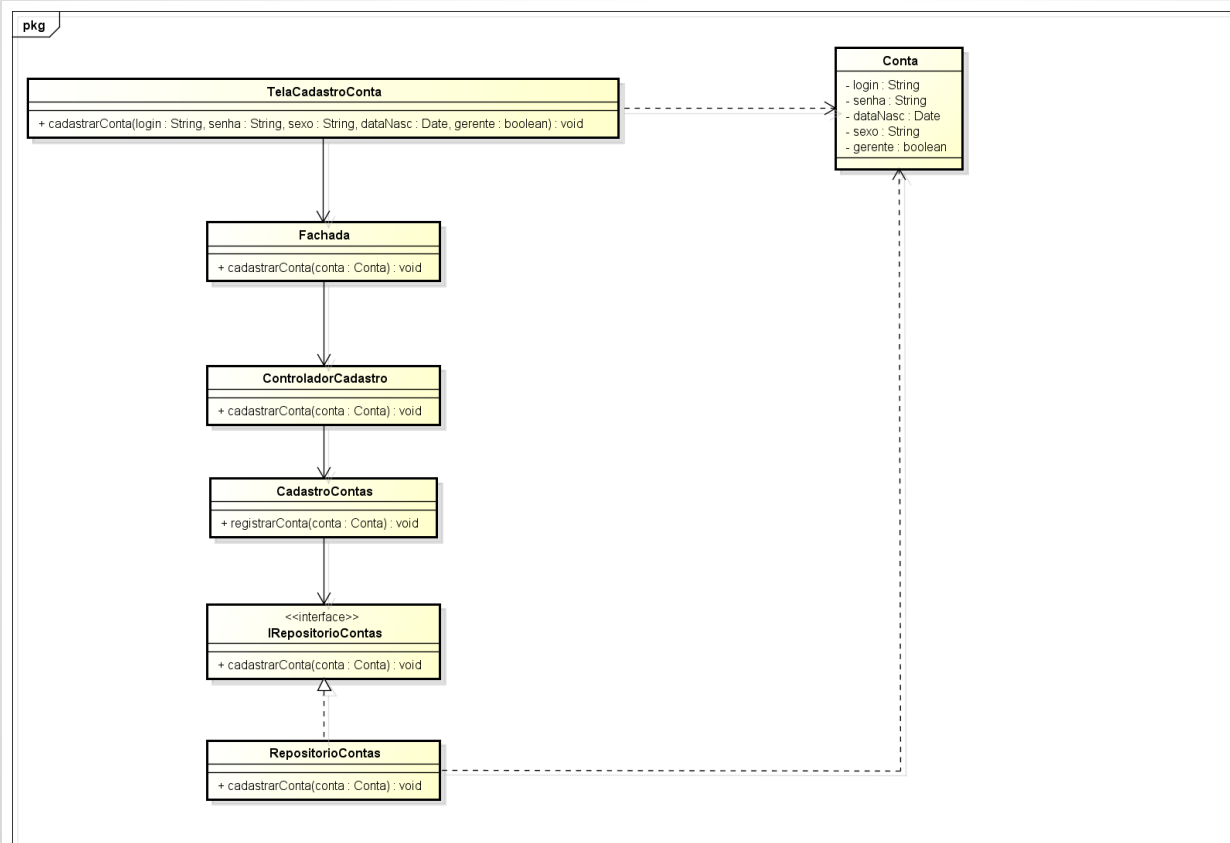

Projeto de Caso de Uso

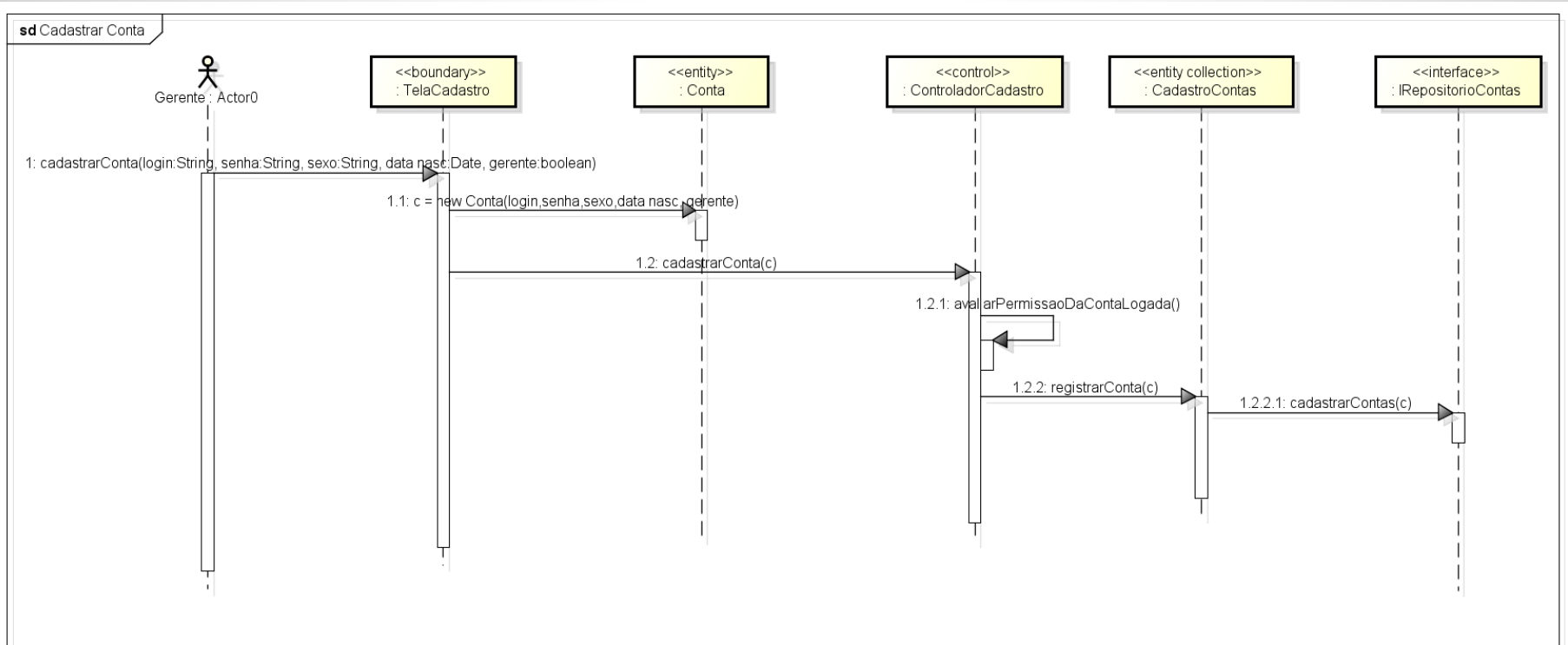

Modelagem SOA

Roteiro

- Casos de Uso
- Especificação do Modelo de Negócio:
 - Modelo de Informação do Negócio
 - Modelo Navegacional
 - Protótipo de Interface Gráfica
- Análise de Serviços:
 - Arquitetura dos Serviços
 - Modelo de Interação dos Serviços
 - Modelo de Informação Refinado
 - Diagrama de Componentes dos Serviços
- Projetar Serviços:
 - Diagrama de Componentes do Sistema
- Projeto detalhado: 3 telas (Fron-end) e 3 componentes Back-end.

Casos de Uso

uc

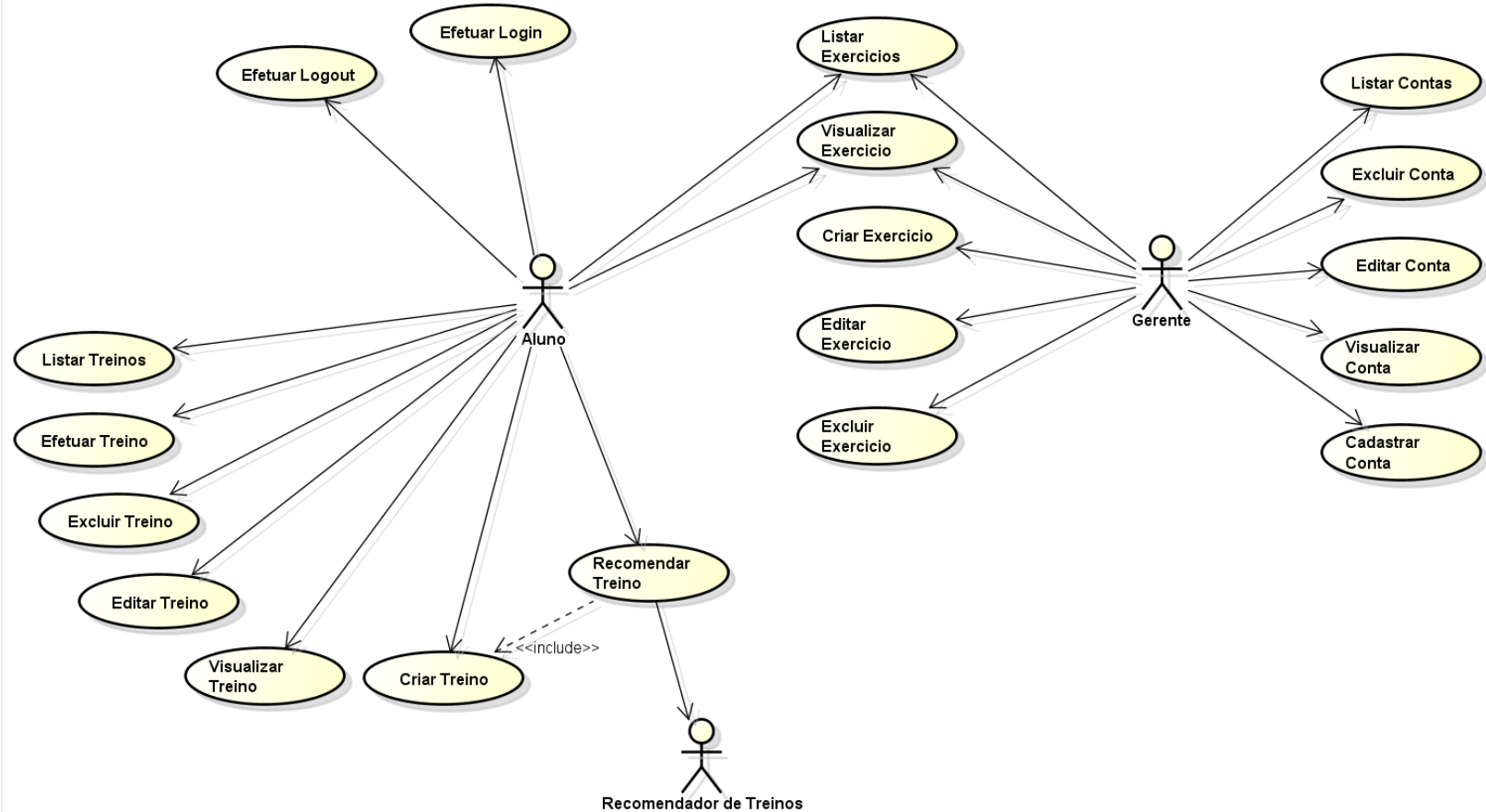

Identificando Serviços

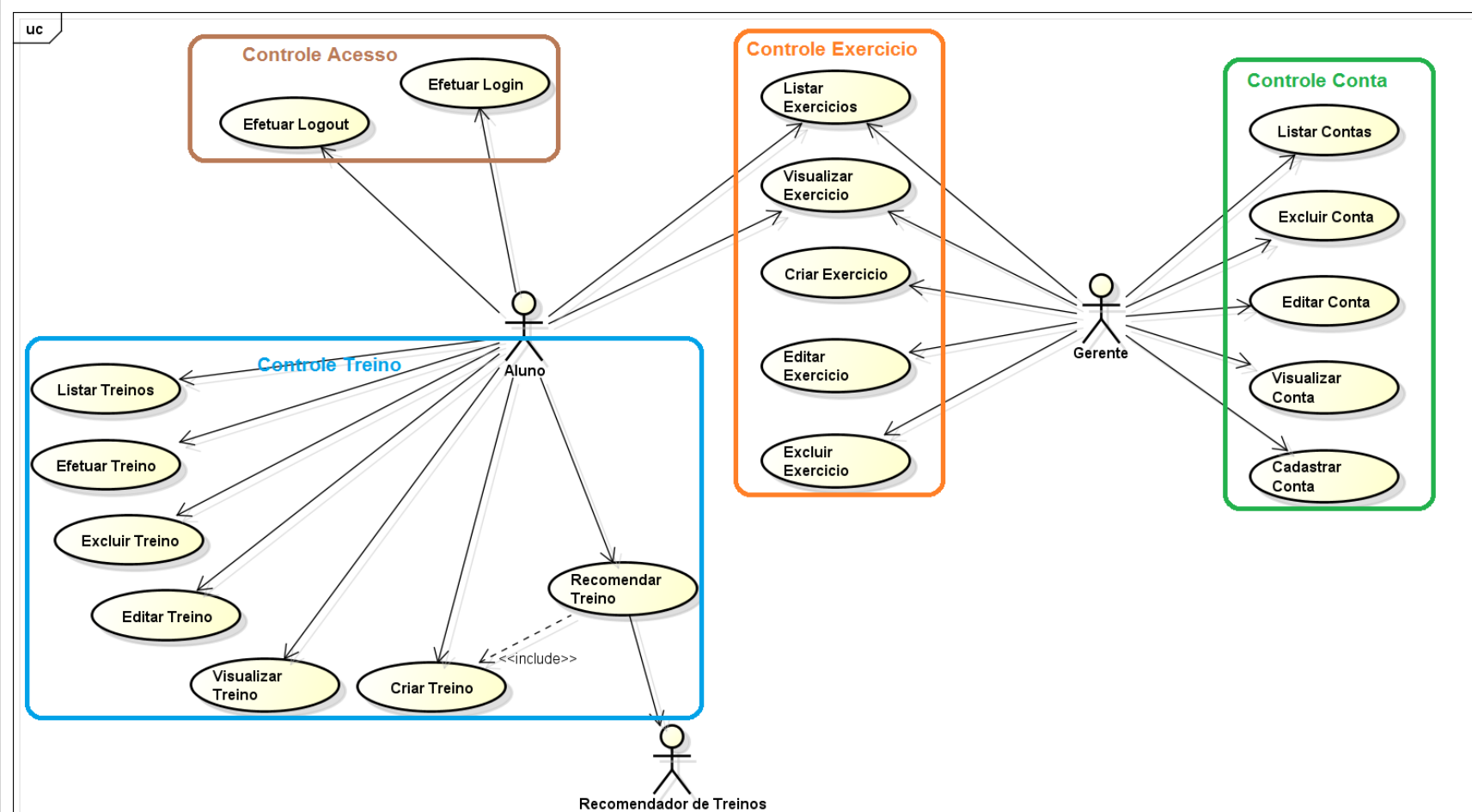

Casos de Uso Empacotados

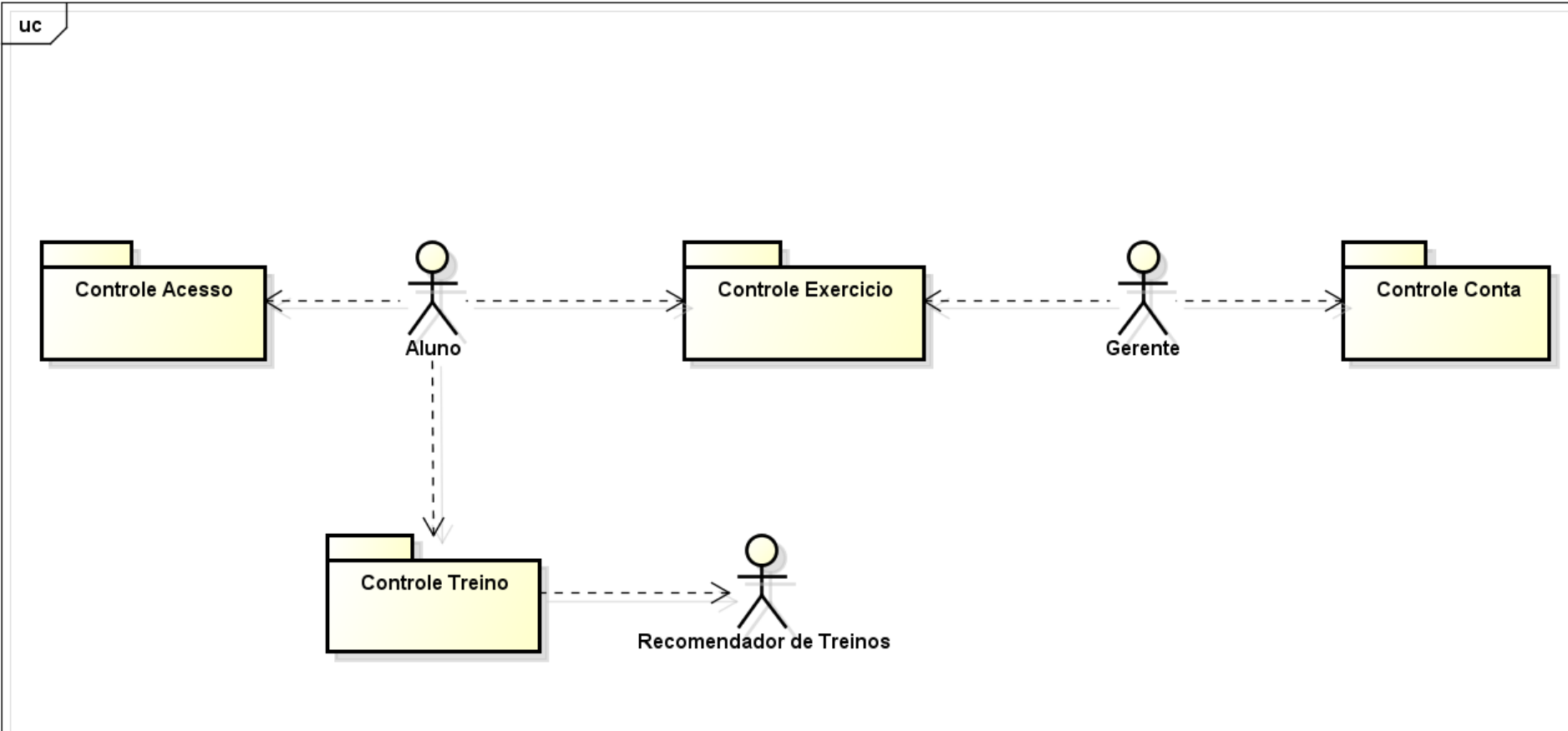

Especificação do Modelo de Negócio

Modelo de Informação do Negócio

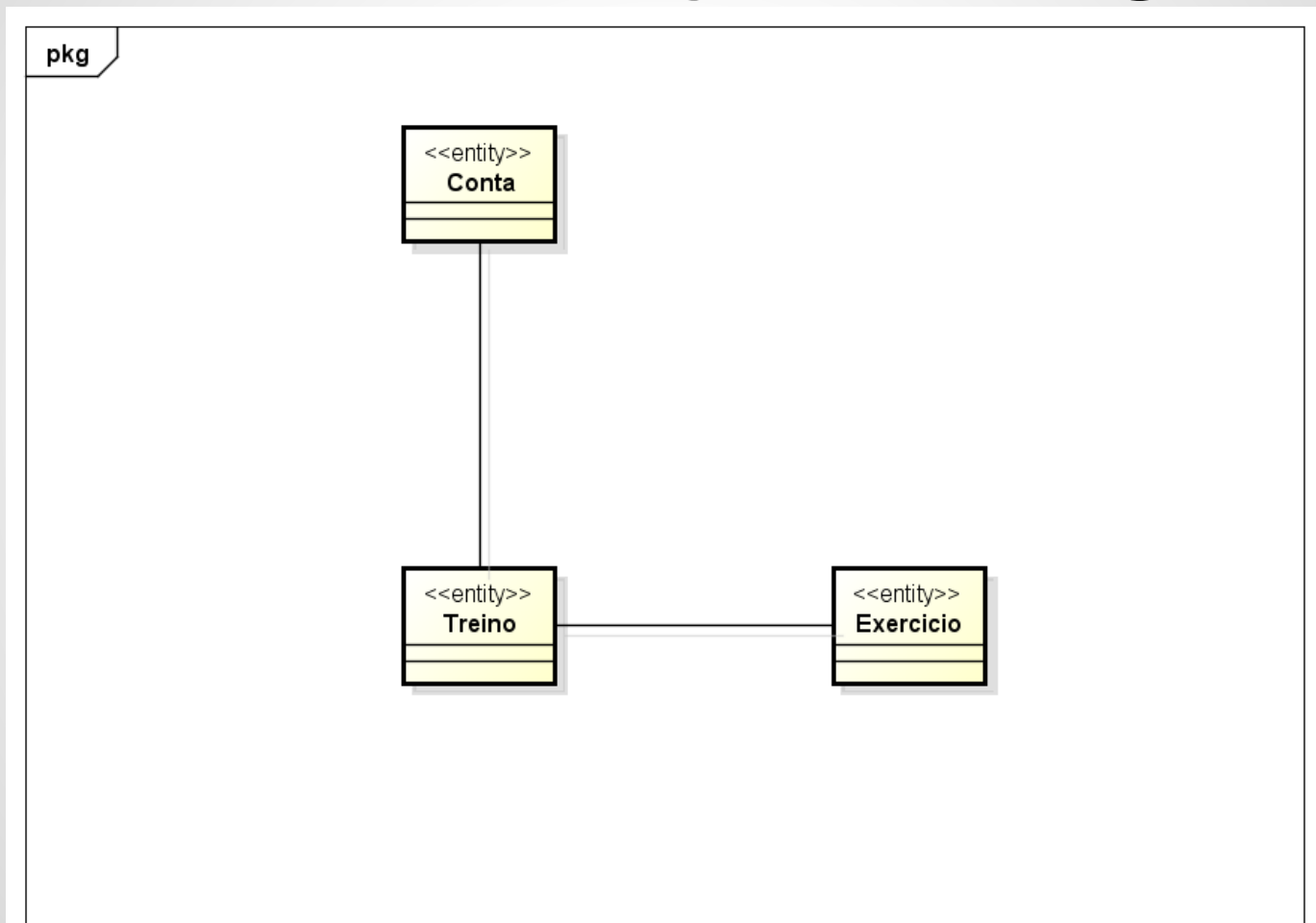

Modelo Navegacional

stm StateMachine Diagram0

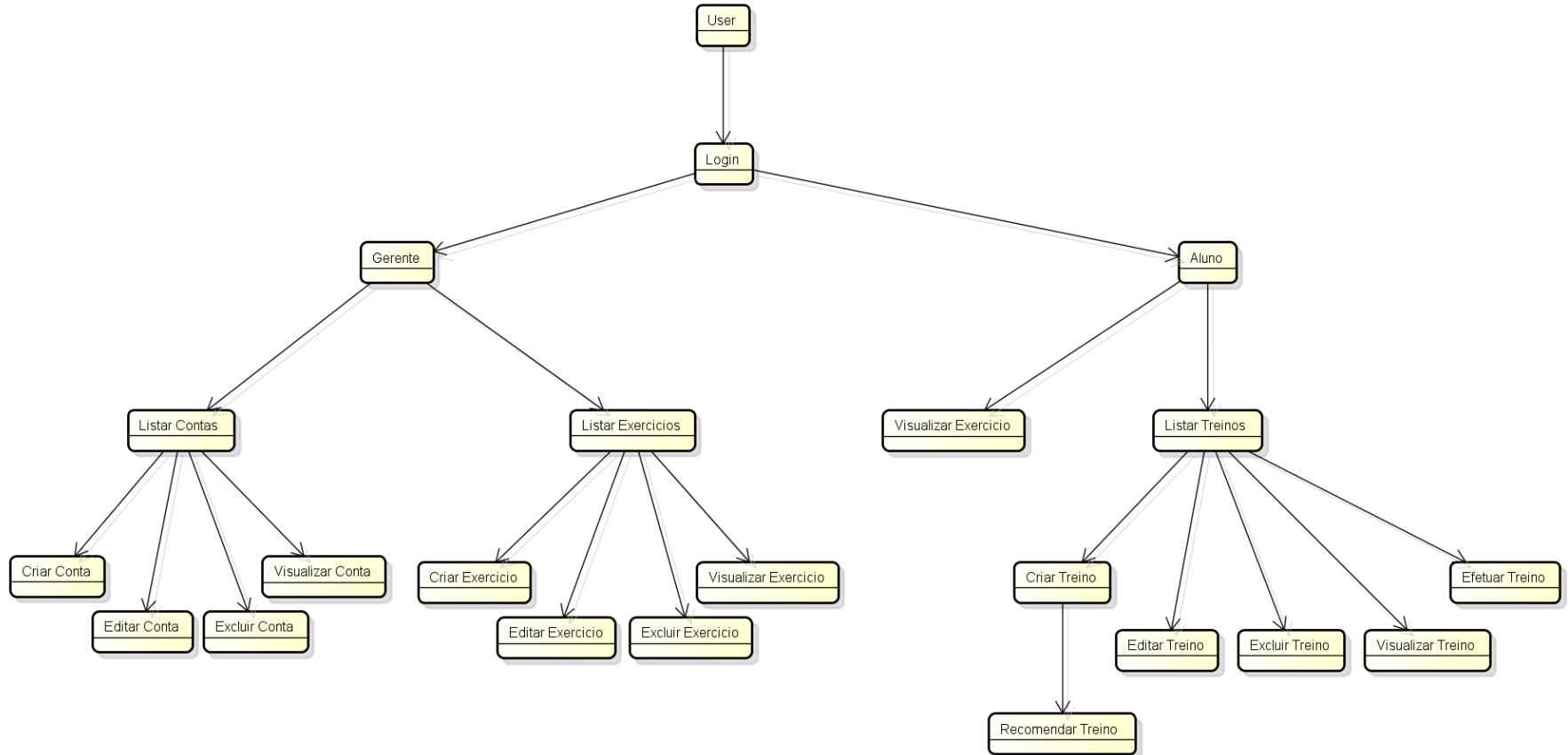

Protótipos de interface gráfica

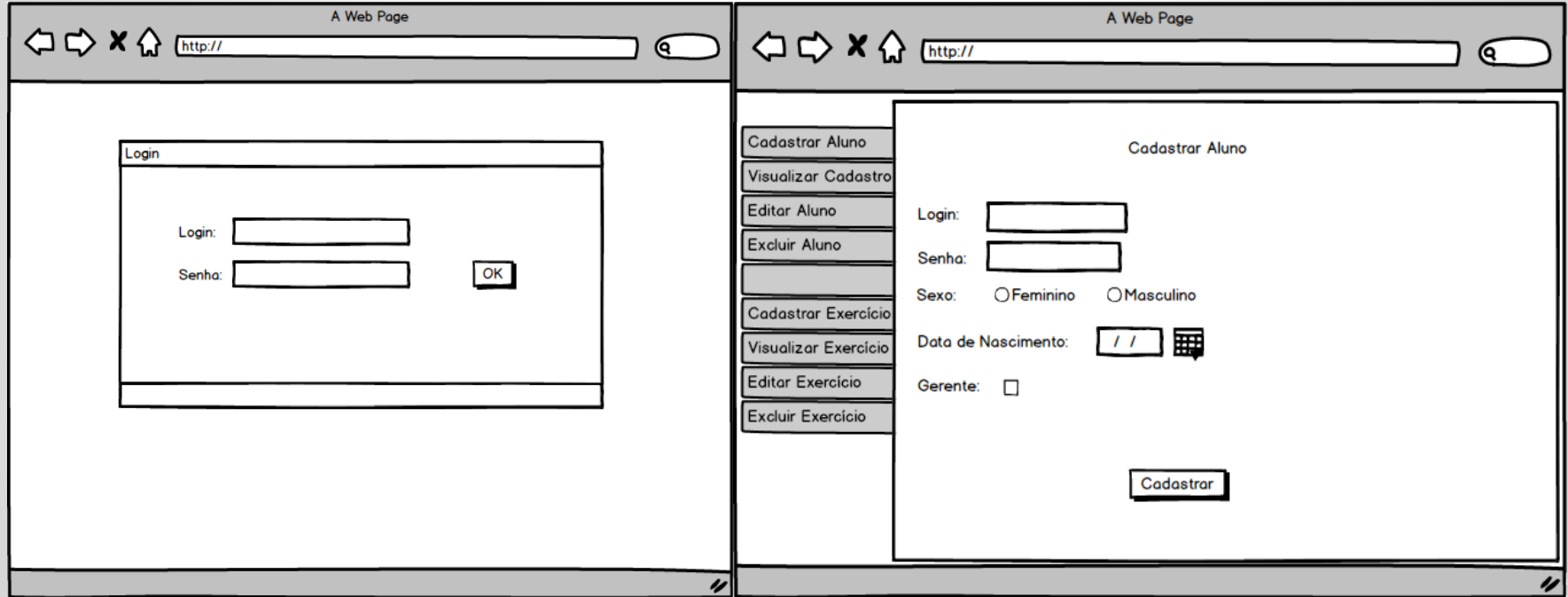

Protótipos de interface gráfica

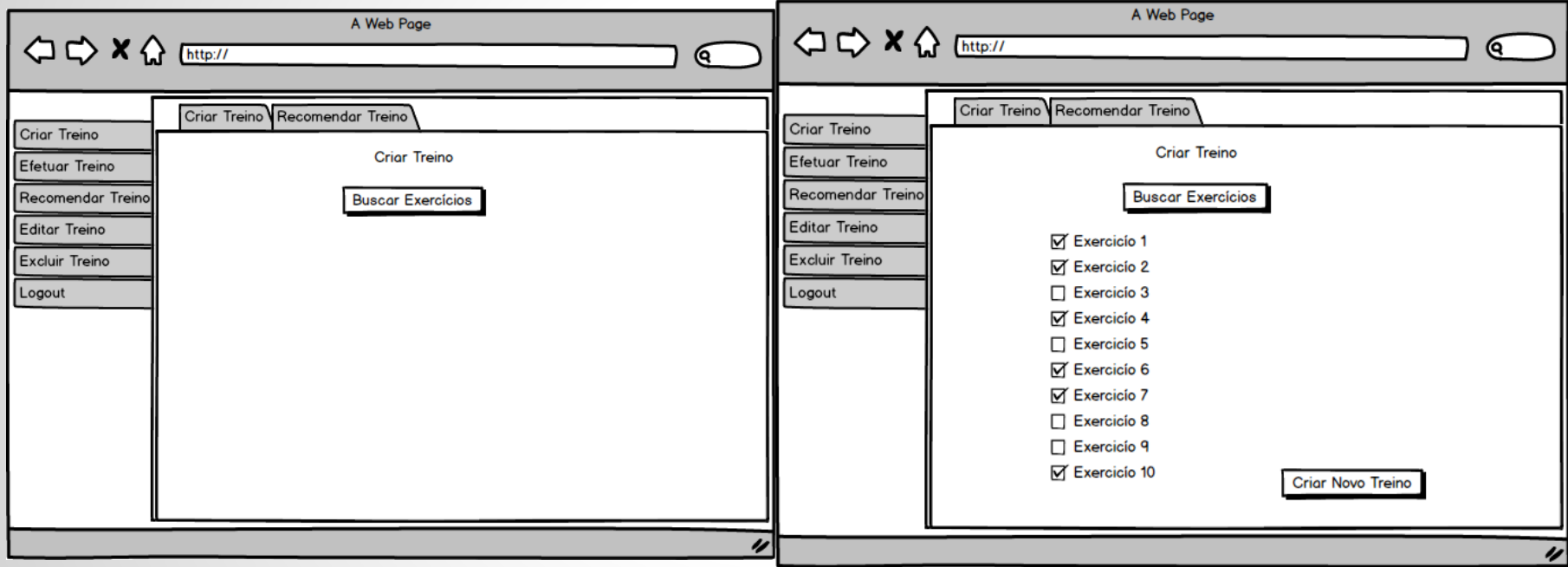

Protótipos de interface gráfica

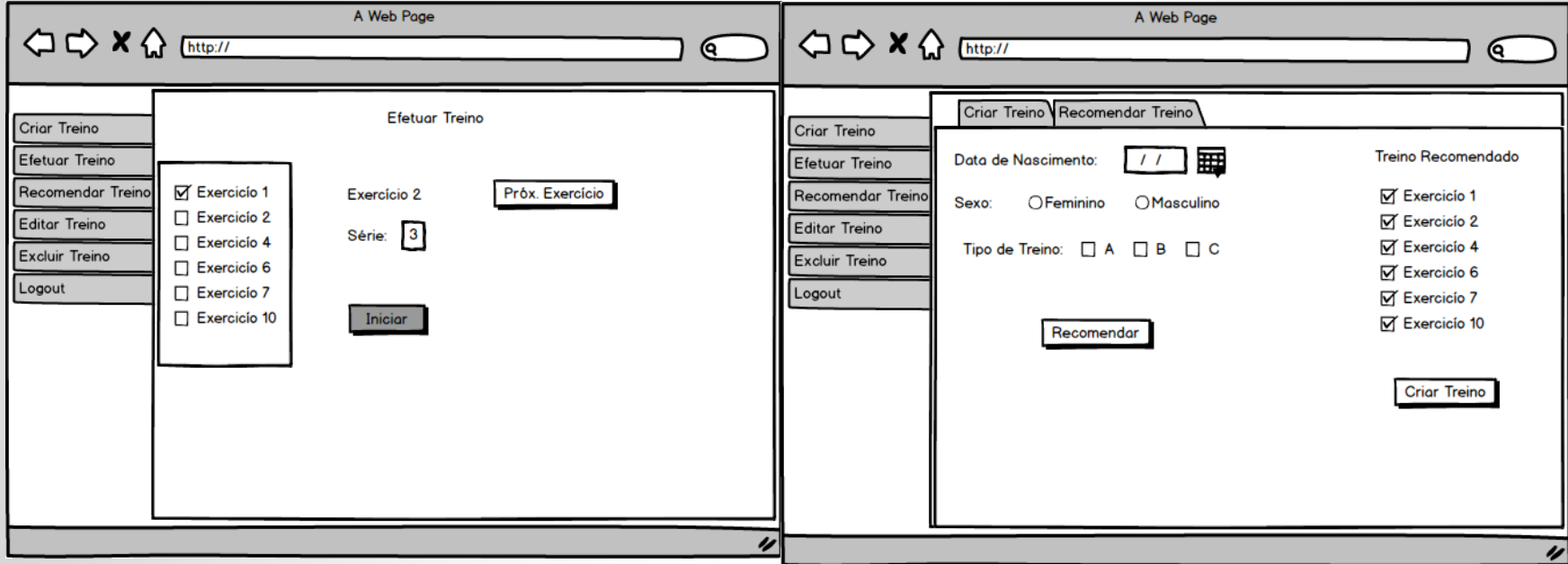

Análise de Serviços

Arquitetura dos Serviços

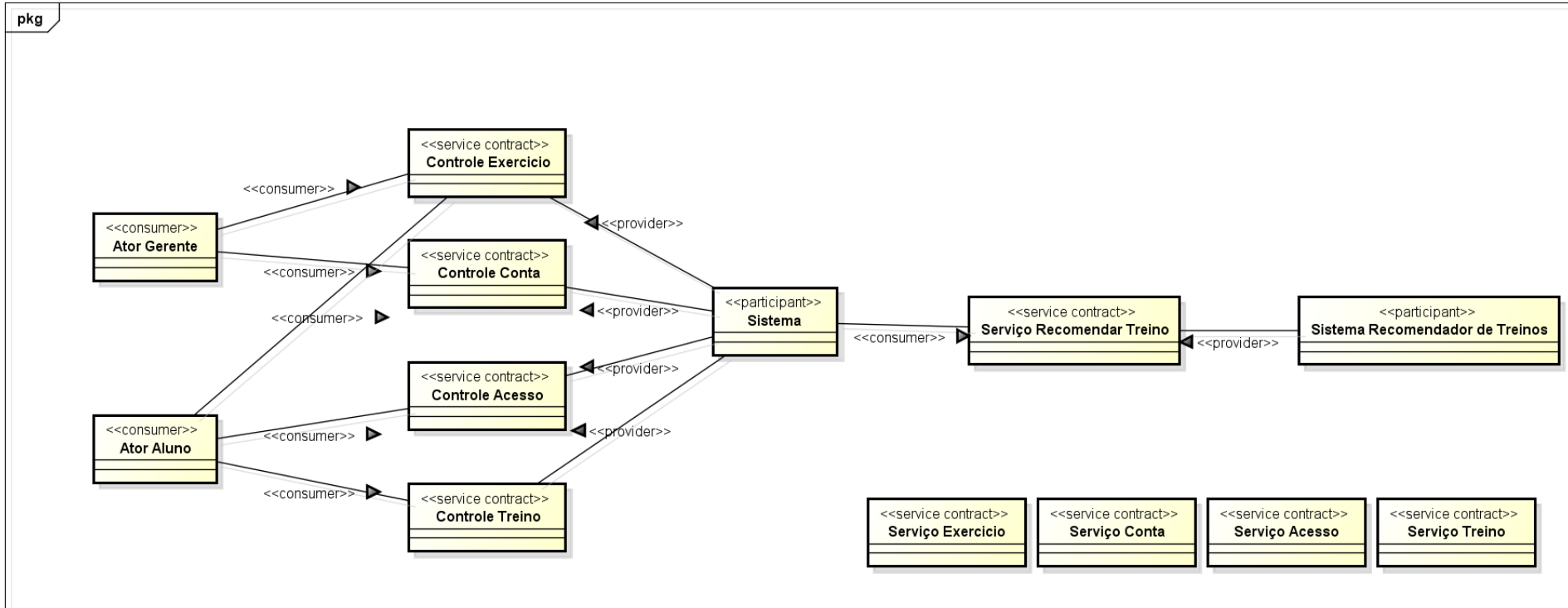

Modelo de Interação - Acesso

sd Sequence Diagram0

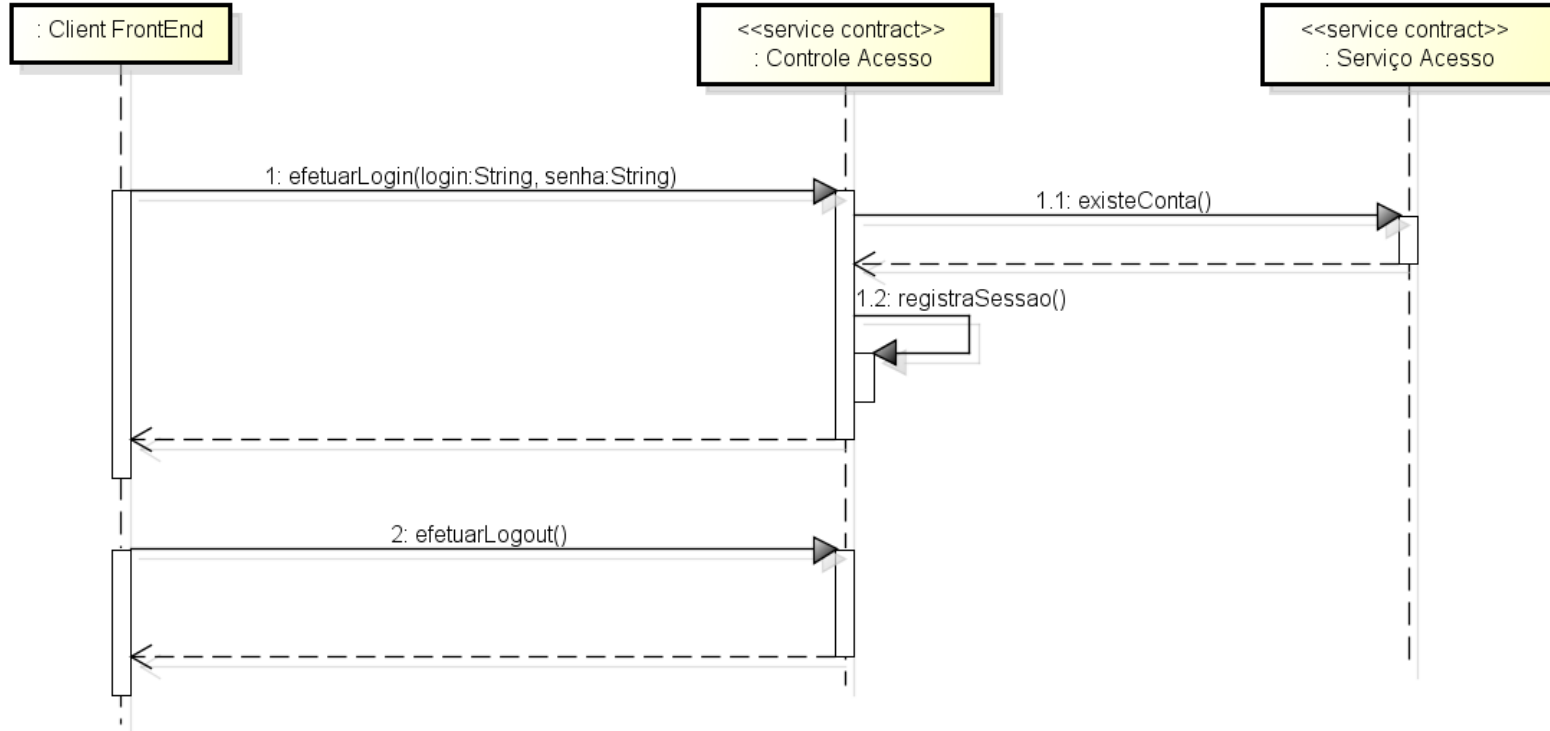

Modelo de Interação - Conta

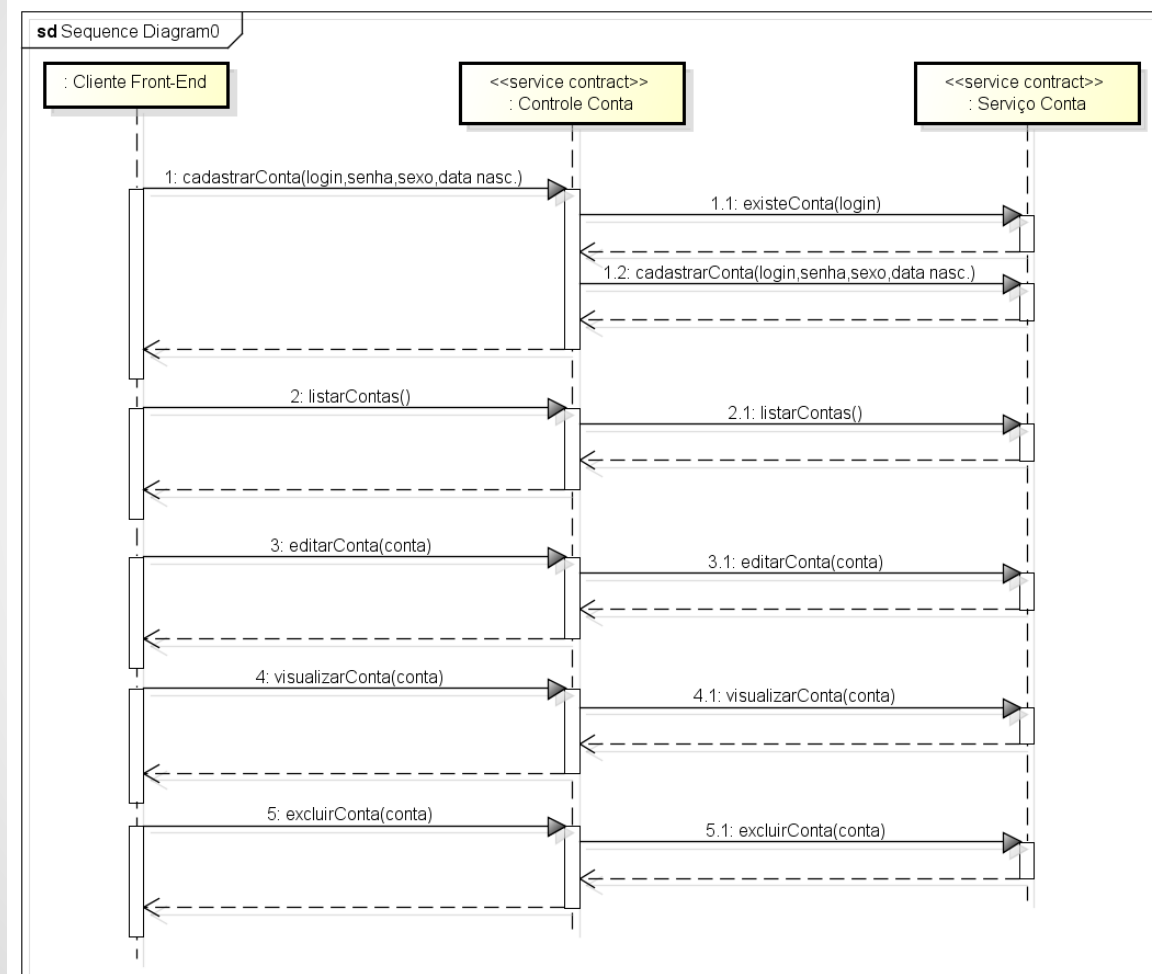

Modelo de Interação - Exercício

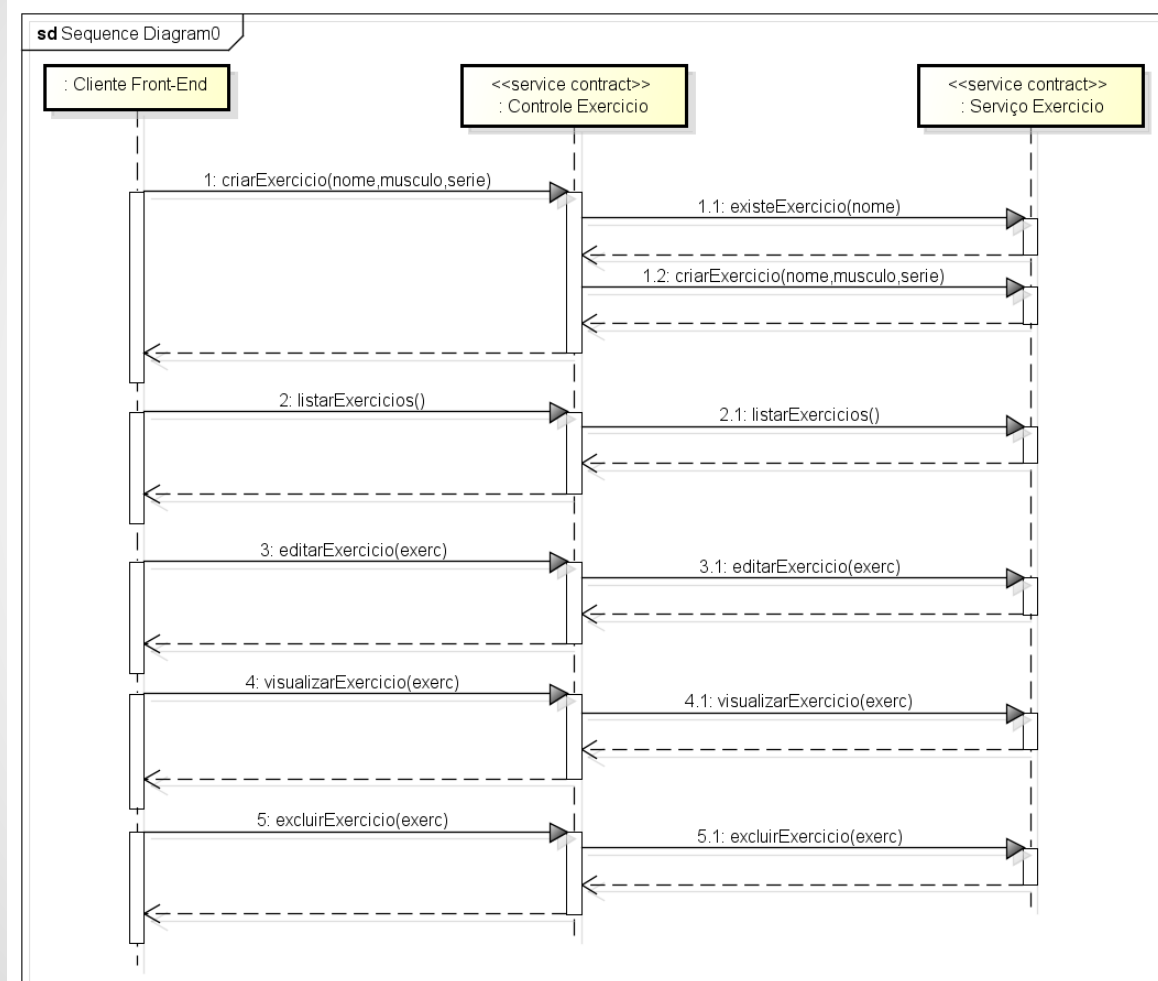

Modelo de Interação - Treino

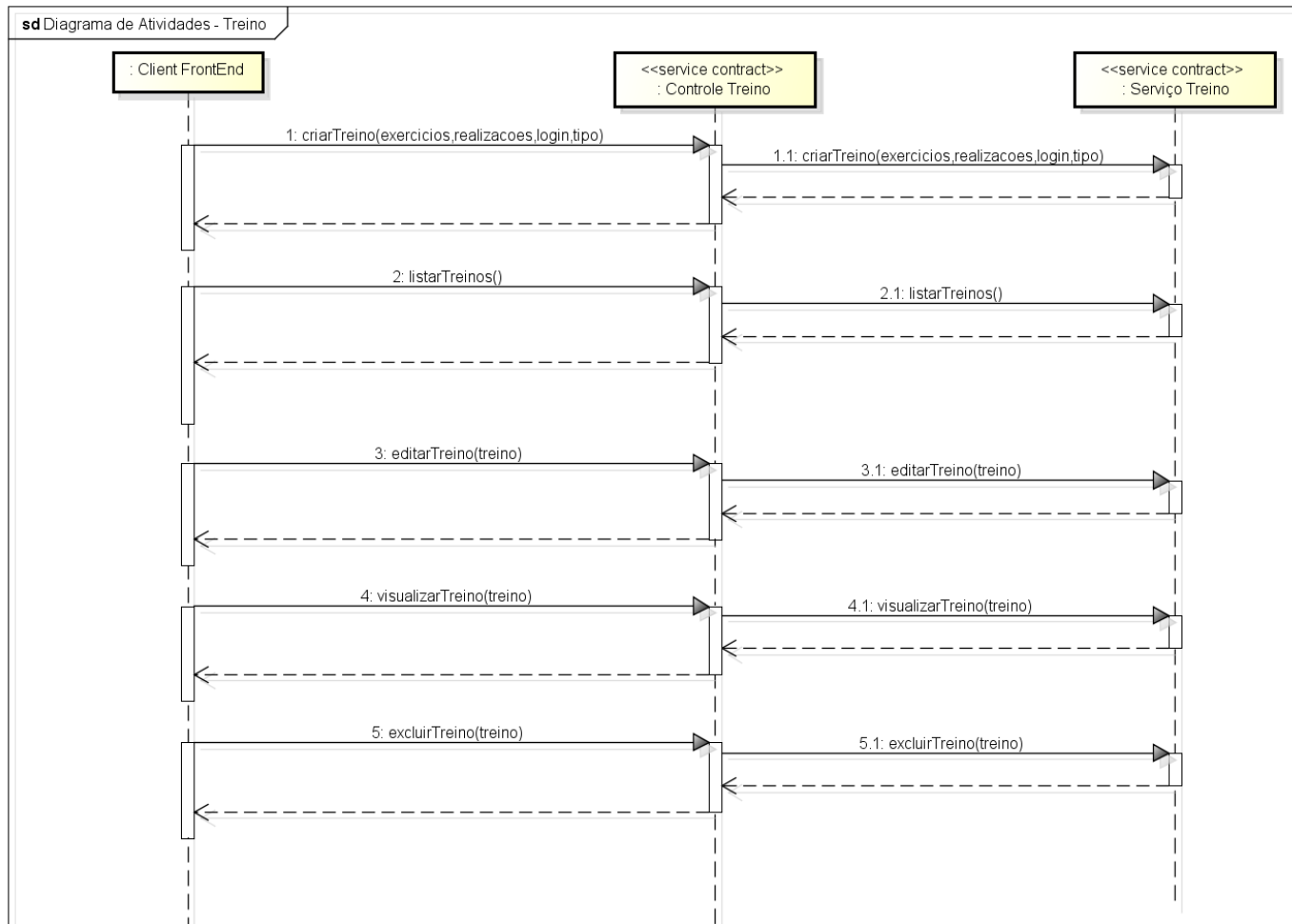

Modelo de Interação - Treino (Parte 2)

sd Diagrama de Atividades - Treino

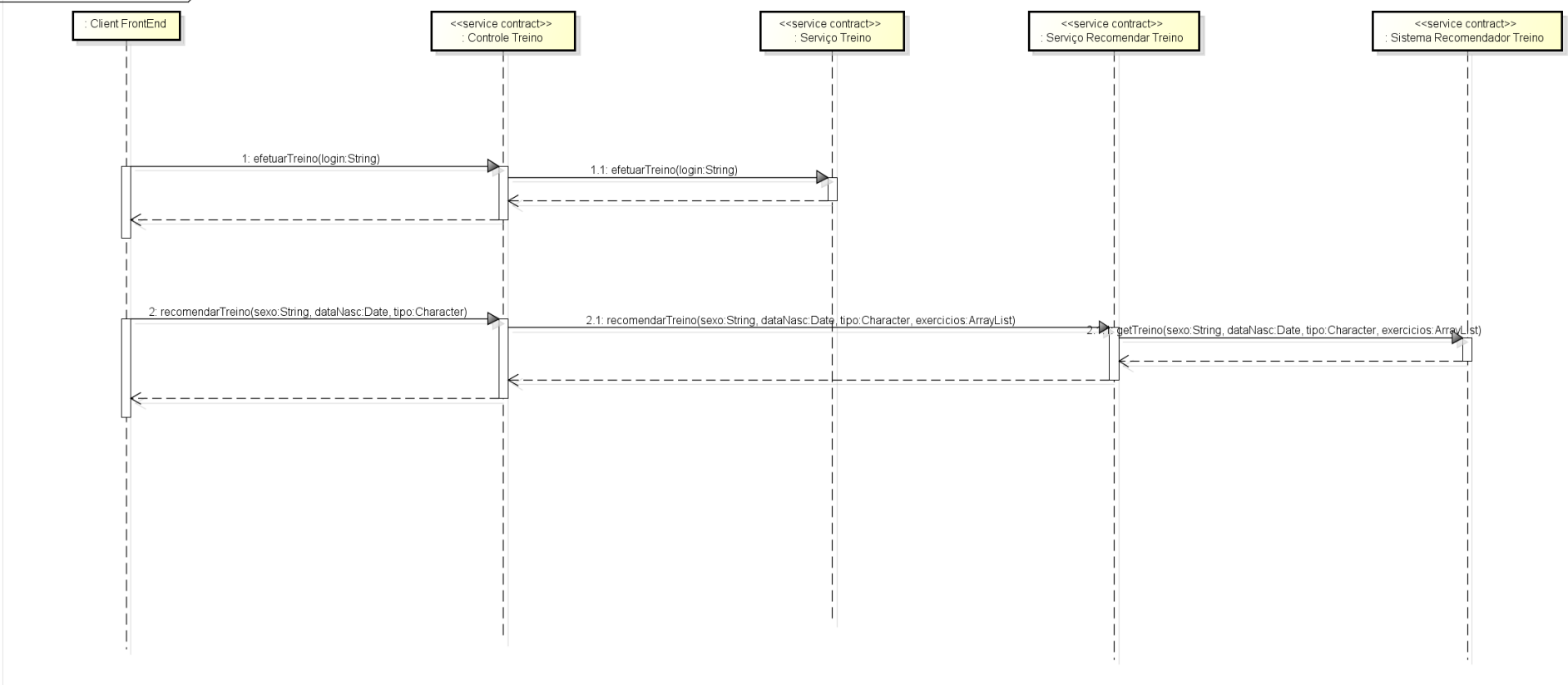

Modelo de Informação de Negócio Refinado



Diagrama de Componentes (análise)



Projetar Serviços

Diagrama de Componentes (expandido)

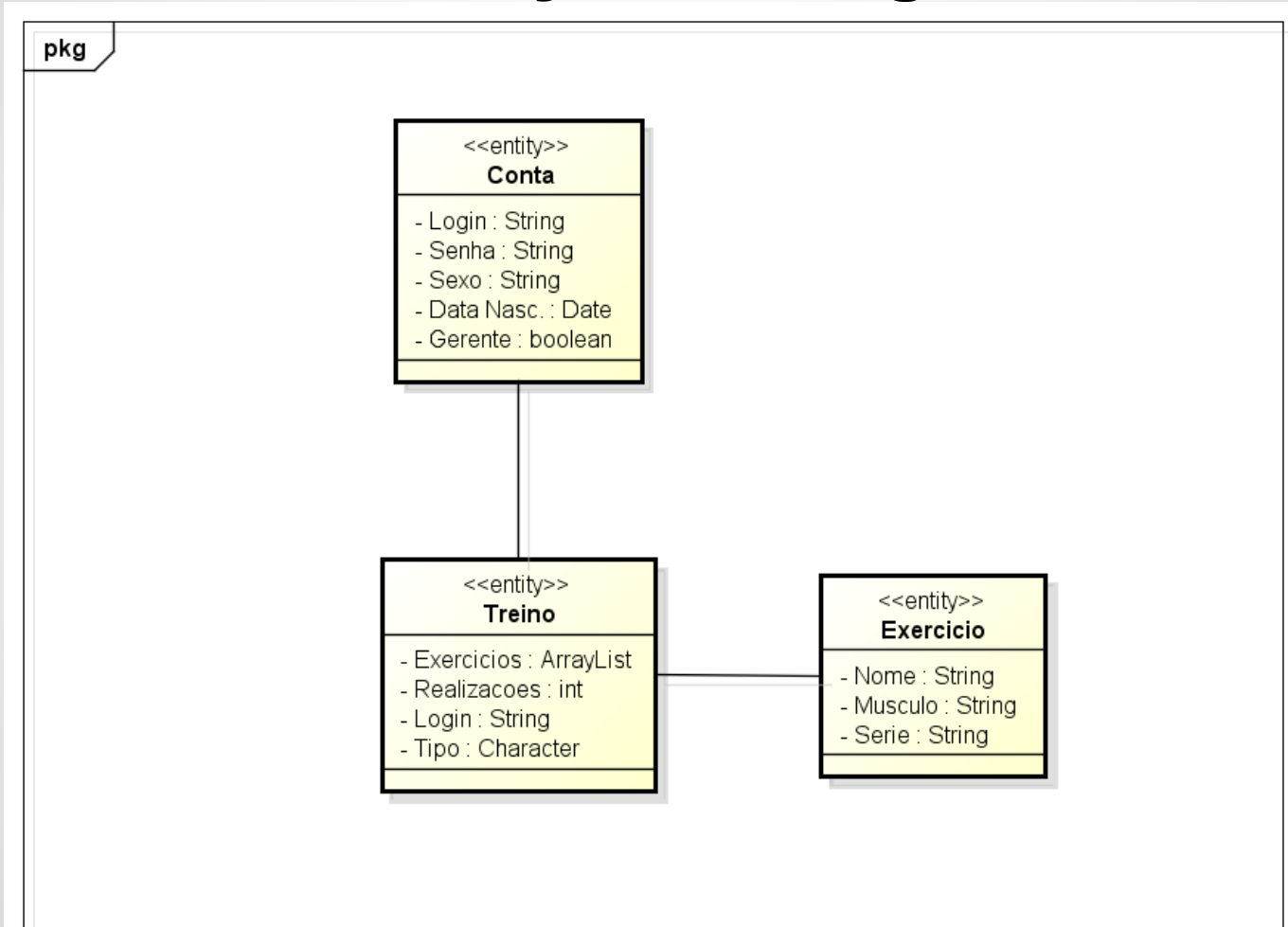
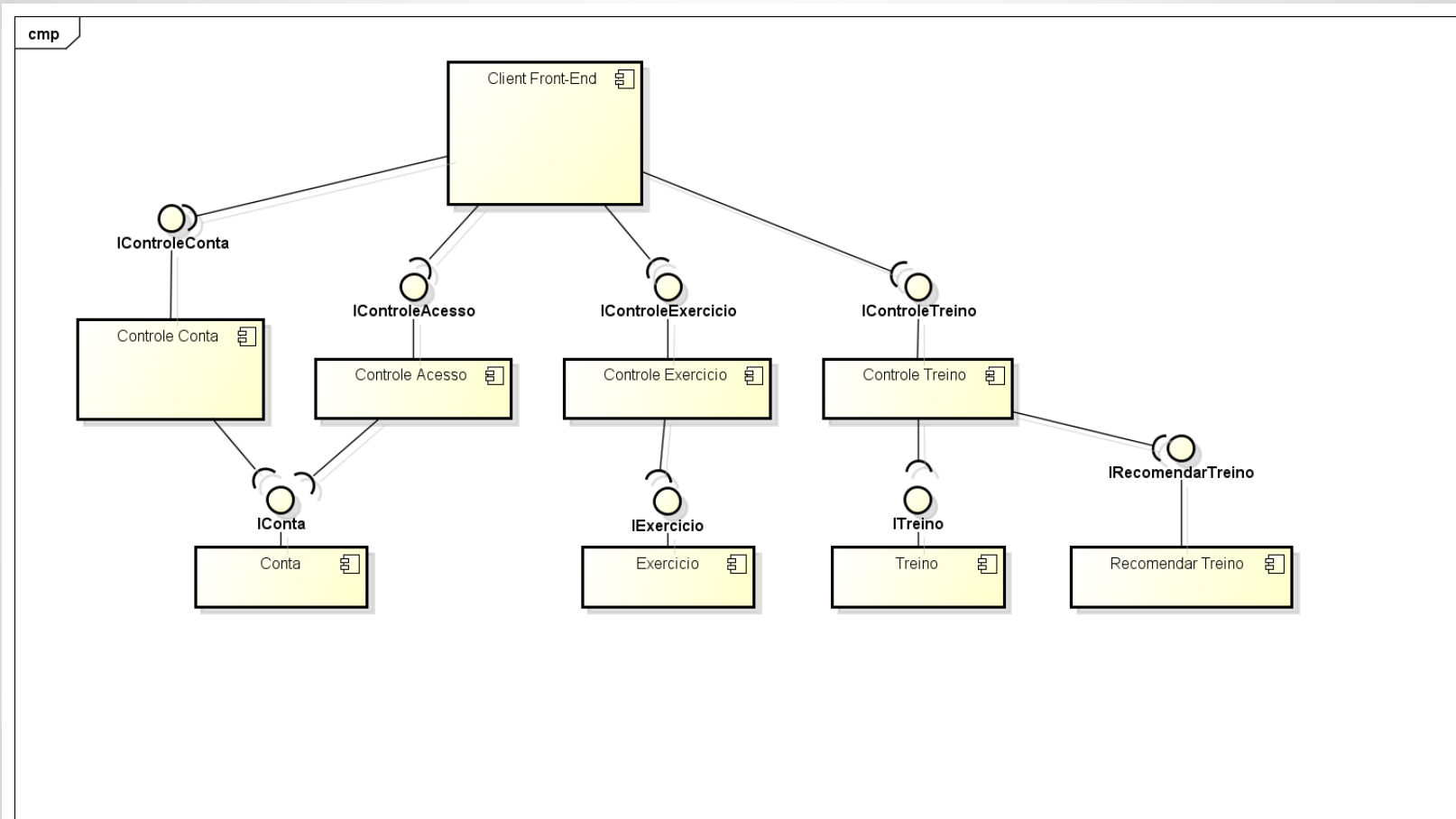
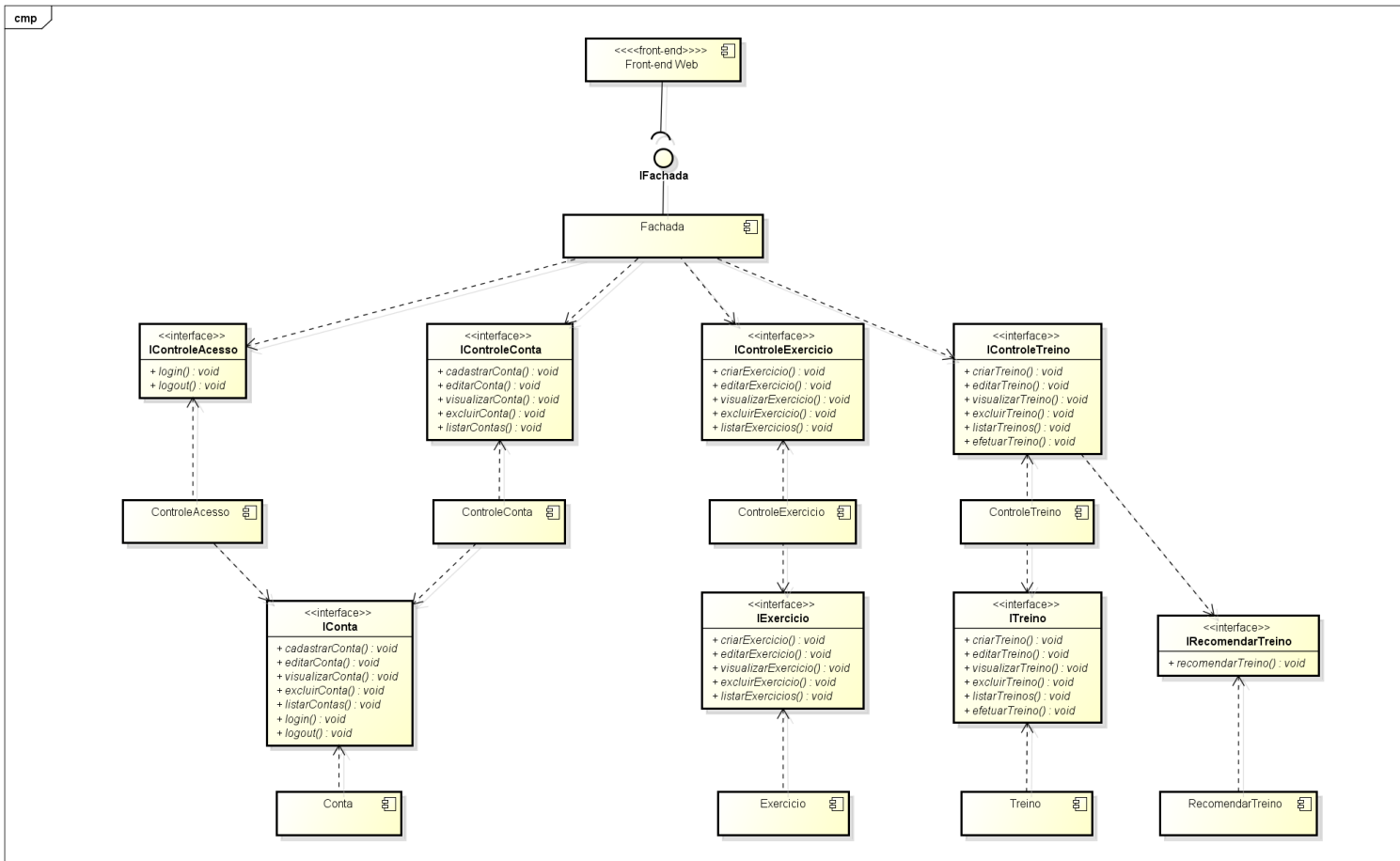

Projeto de Back-end

Projeto de Back-end

- Controle Acesso (classe)

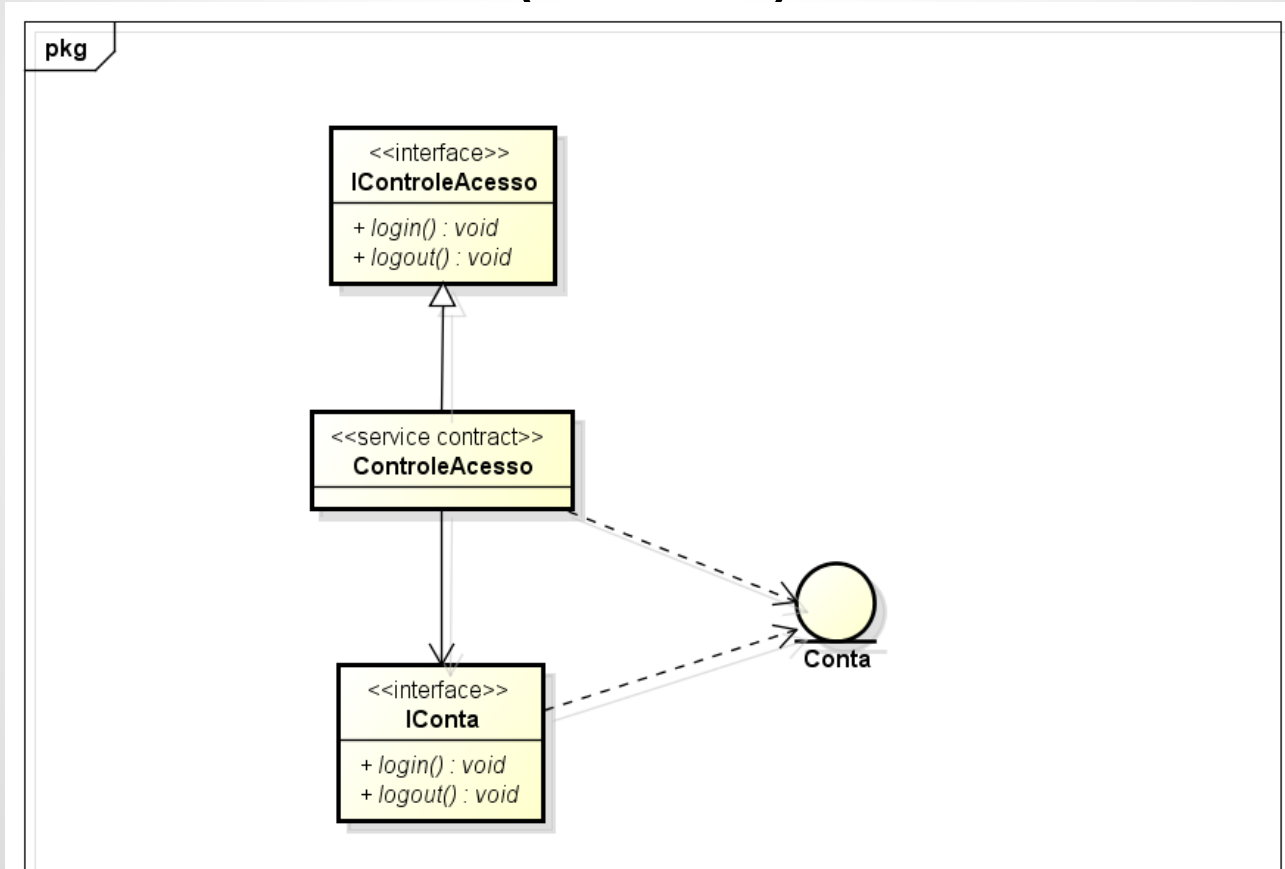

Projeto de Back-end

- Controle Acesso (sequência)

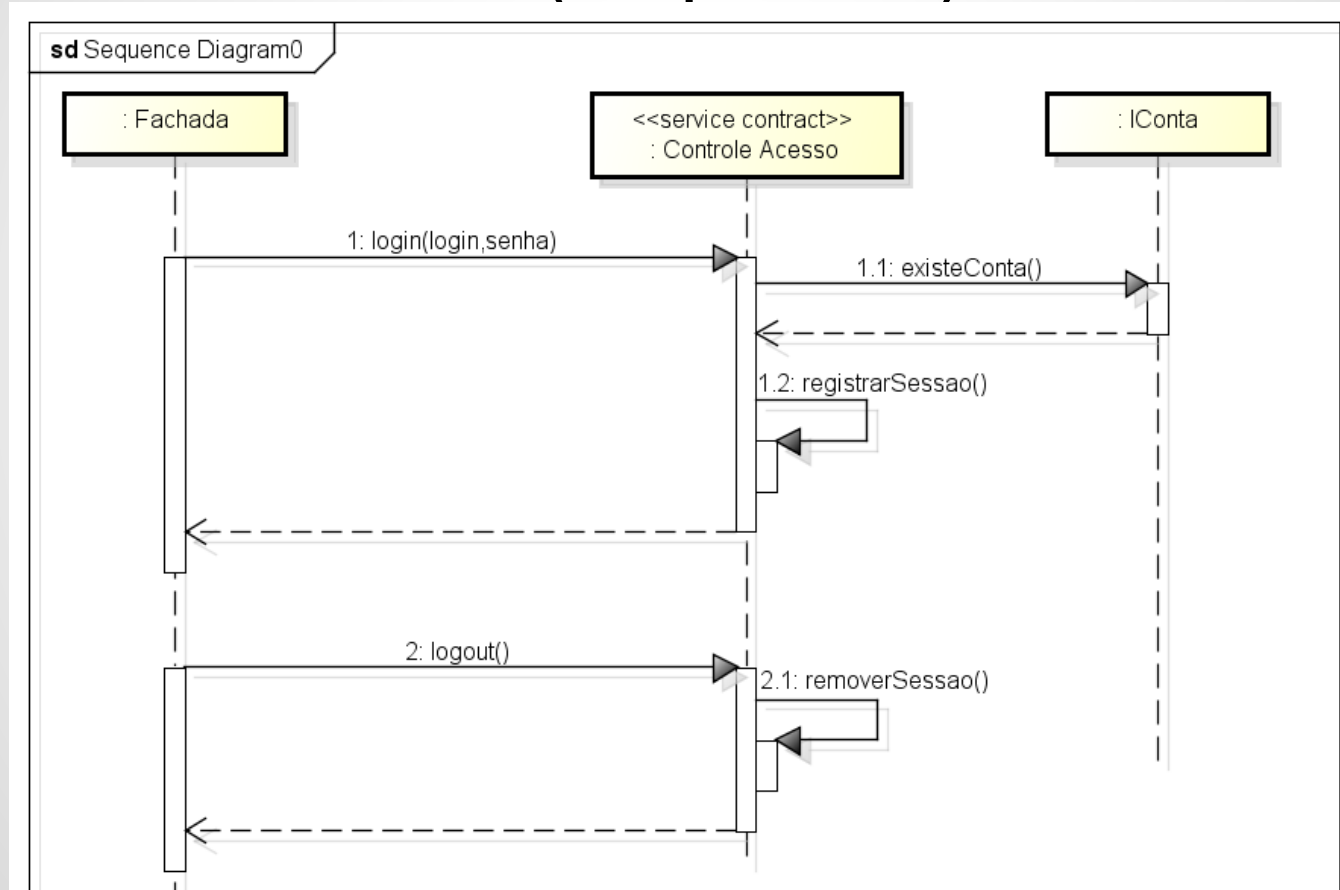

Projeto de Back-end

- Controle Conta (classe)

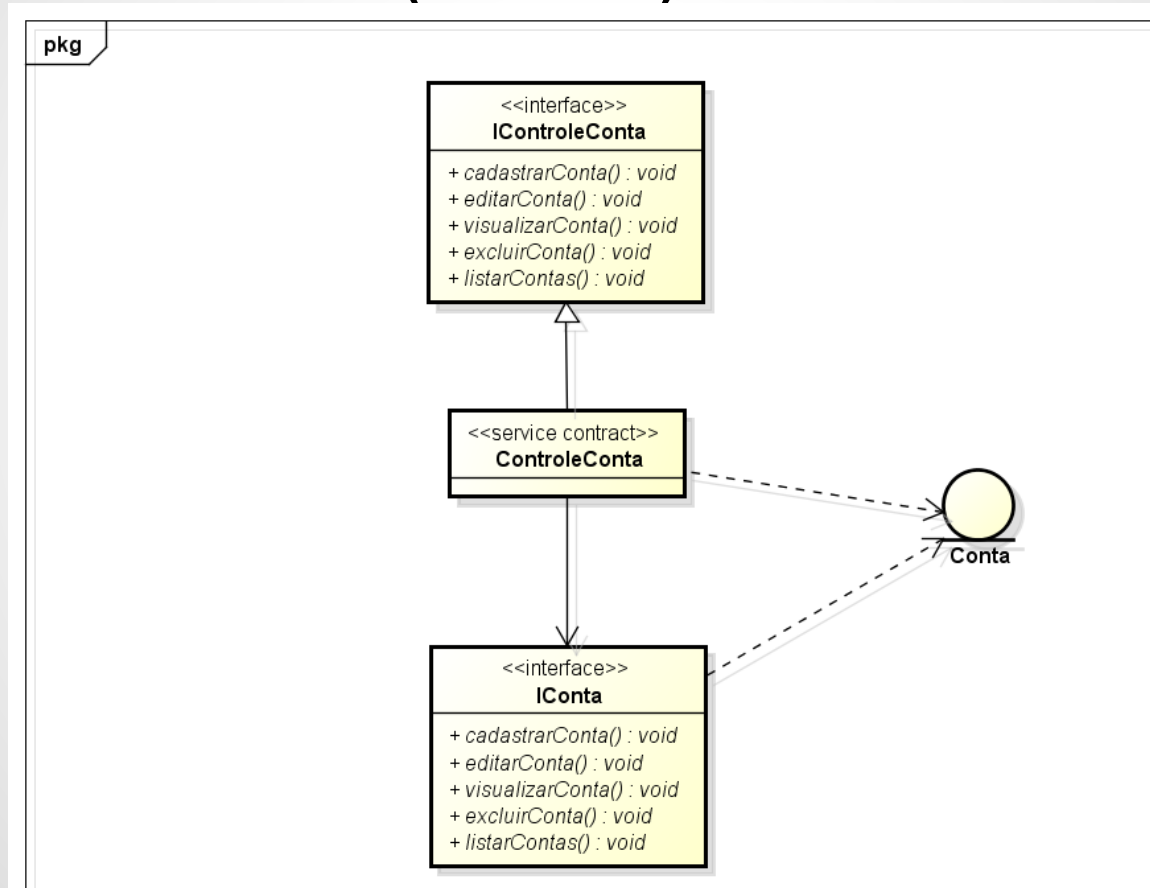

Projeto de Back-end

- Controle Conta (sequência)

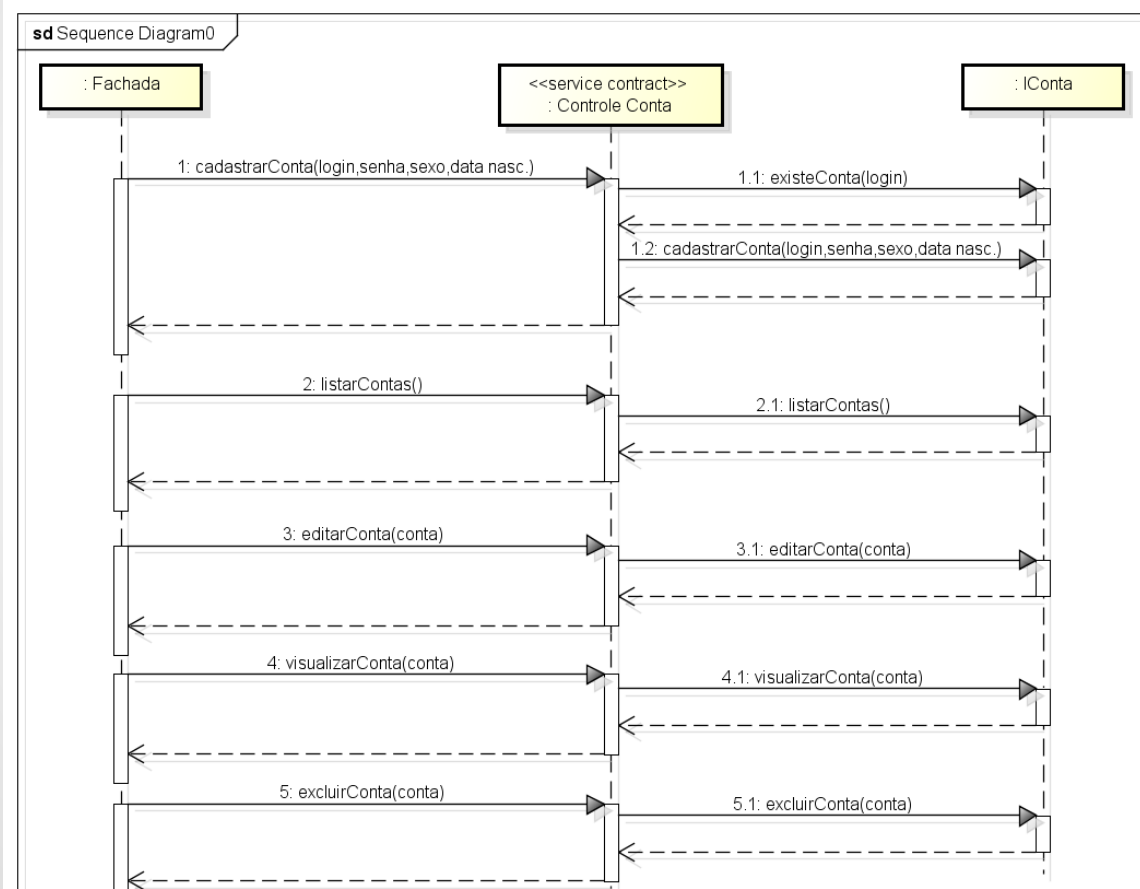

Projeto de Back-end

- Controle Exercicio (classe)

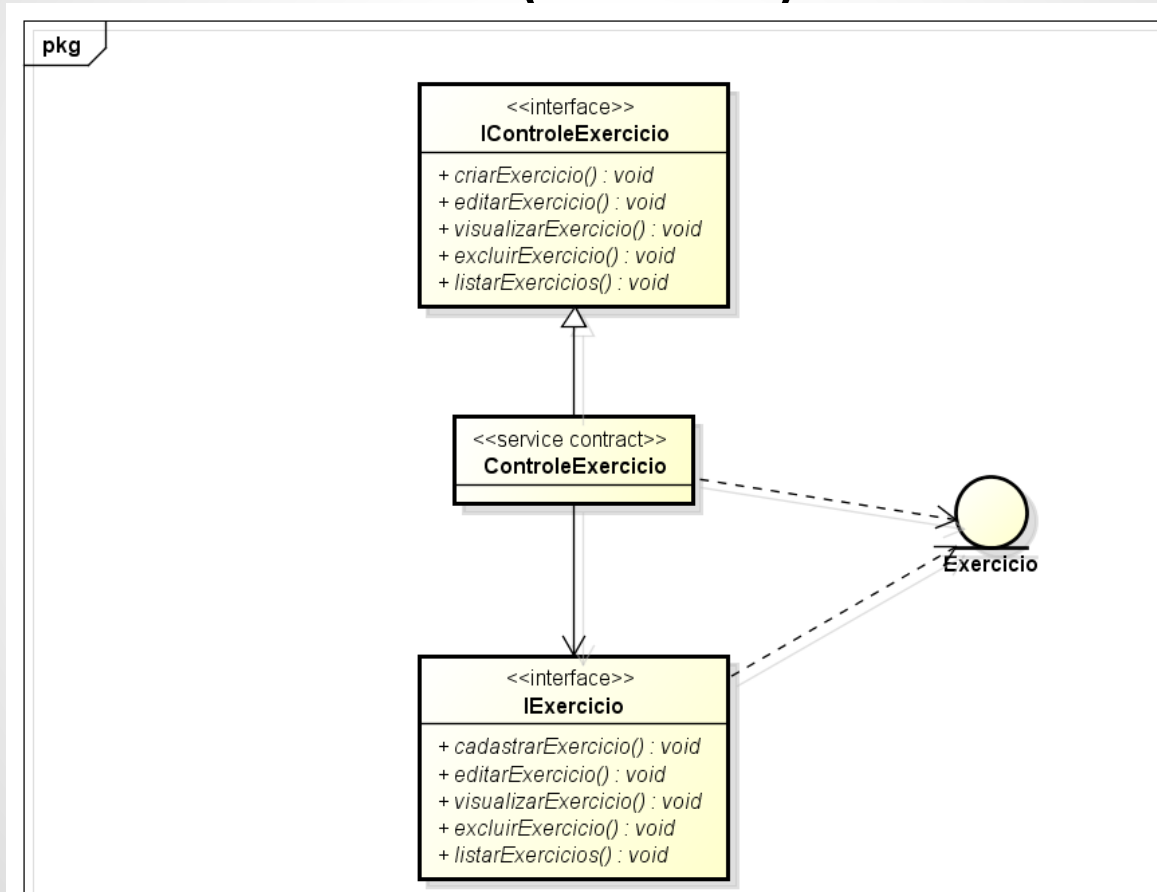

Projeto de Back-end

- Controle Exercício (sequência)

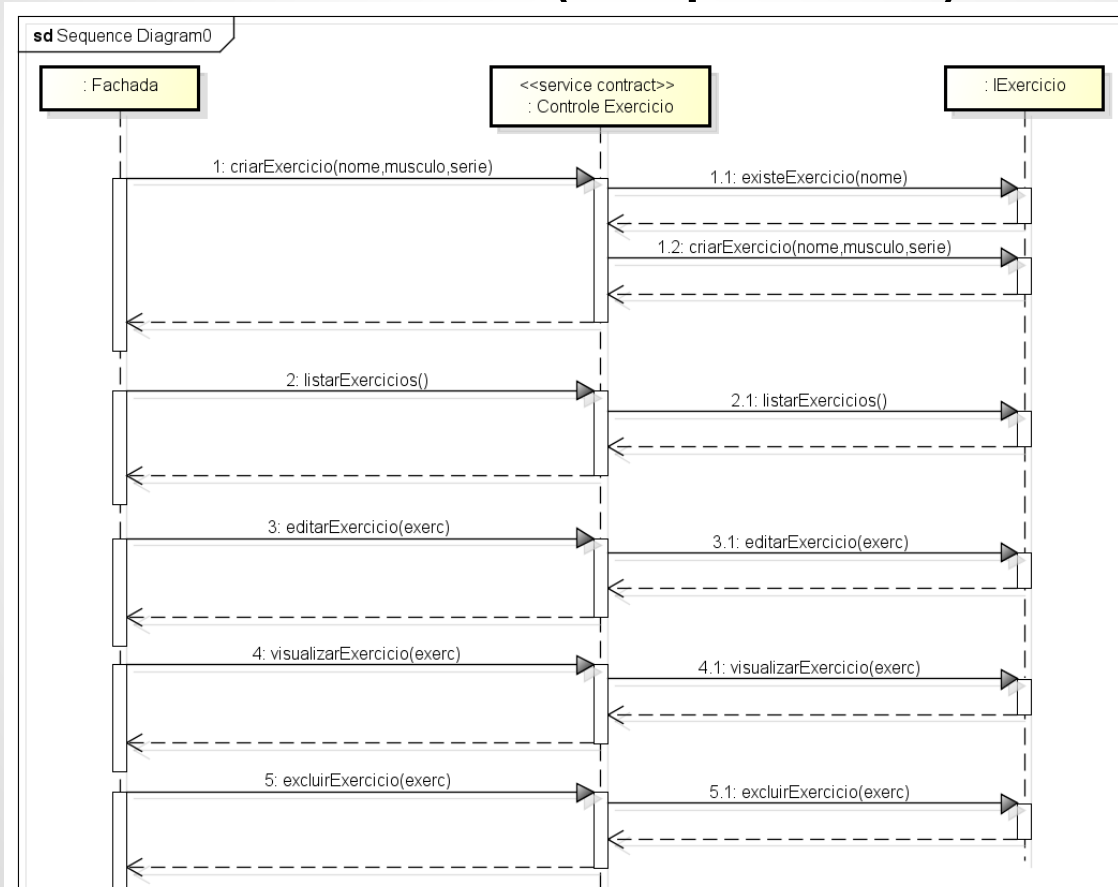

Projeto de Front-end

Projeto de Front-end

- Login (classe)

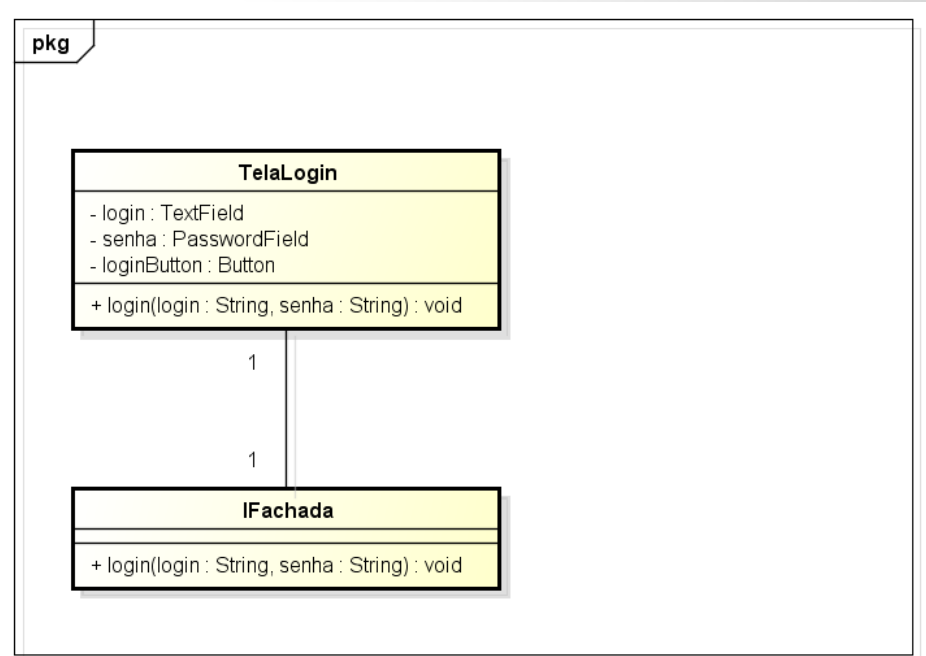
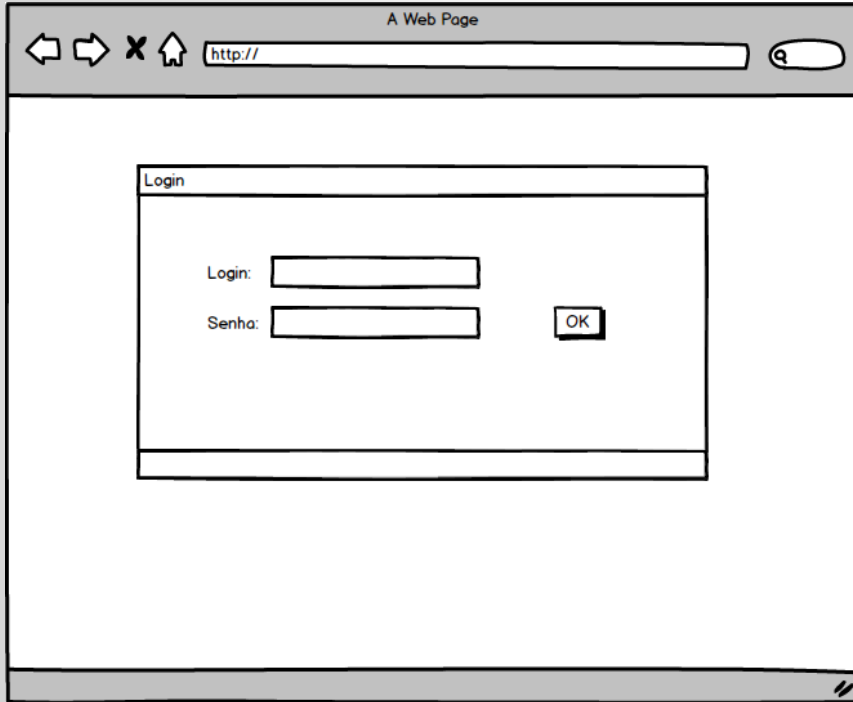

Projeto de Front-end

- Login (sequência)

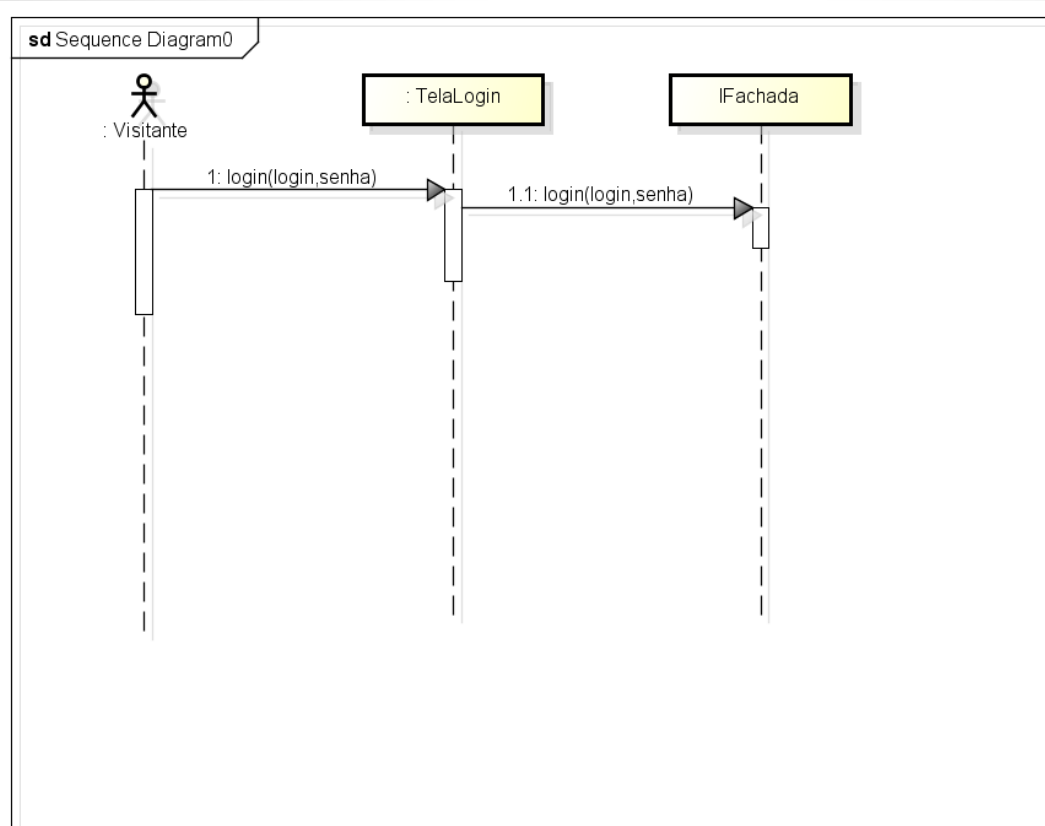

Projeto de Front-end

- Cadastrar Conta (classe)

A Web Page

http://

Cadastrar Aluno

Visualizar Cadastro

Editar Aluno

Excluir Aluno

Cadastrar Exercício

Visualizar Exercício

Editar Exercício

Excluir Exercício

Cadastrar Aluno

Login:

Senha:

Sexo: Feminino Masculino

Data de Nascimento: /

Gerente:

Cadastrar

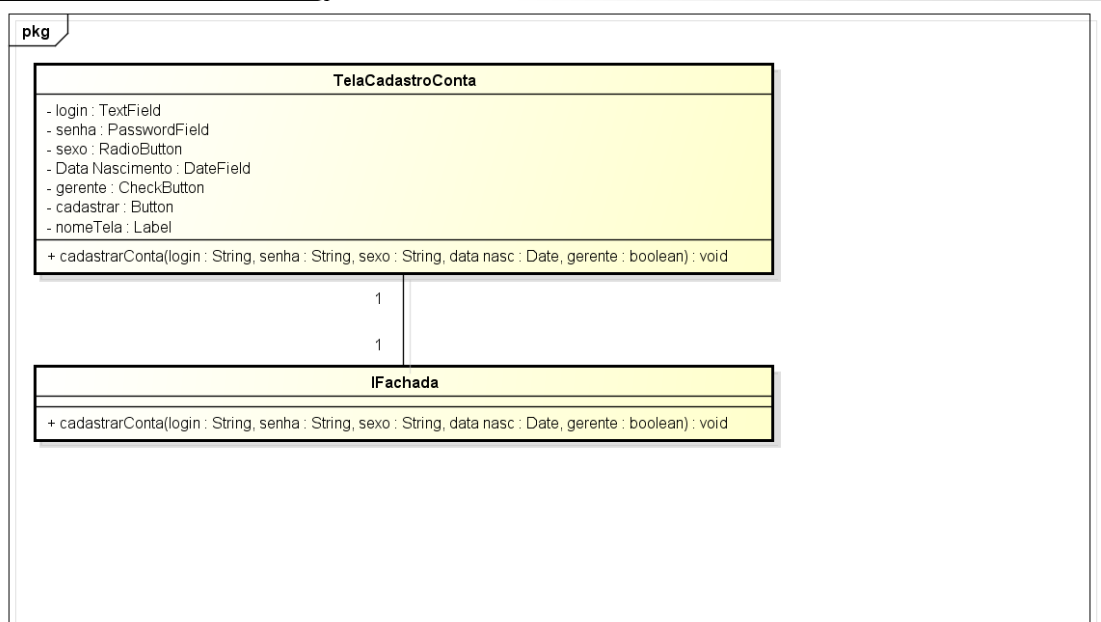

Projeto de Front-end

- Cadastrar Conta (sequência)

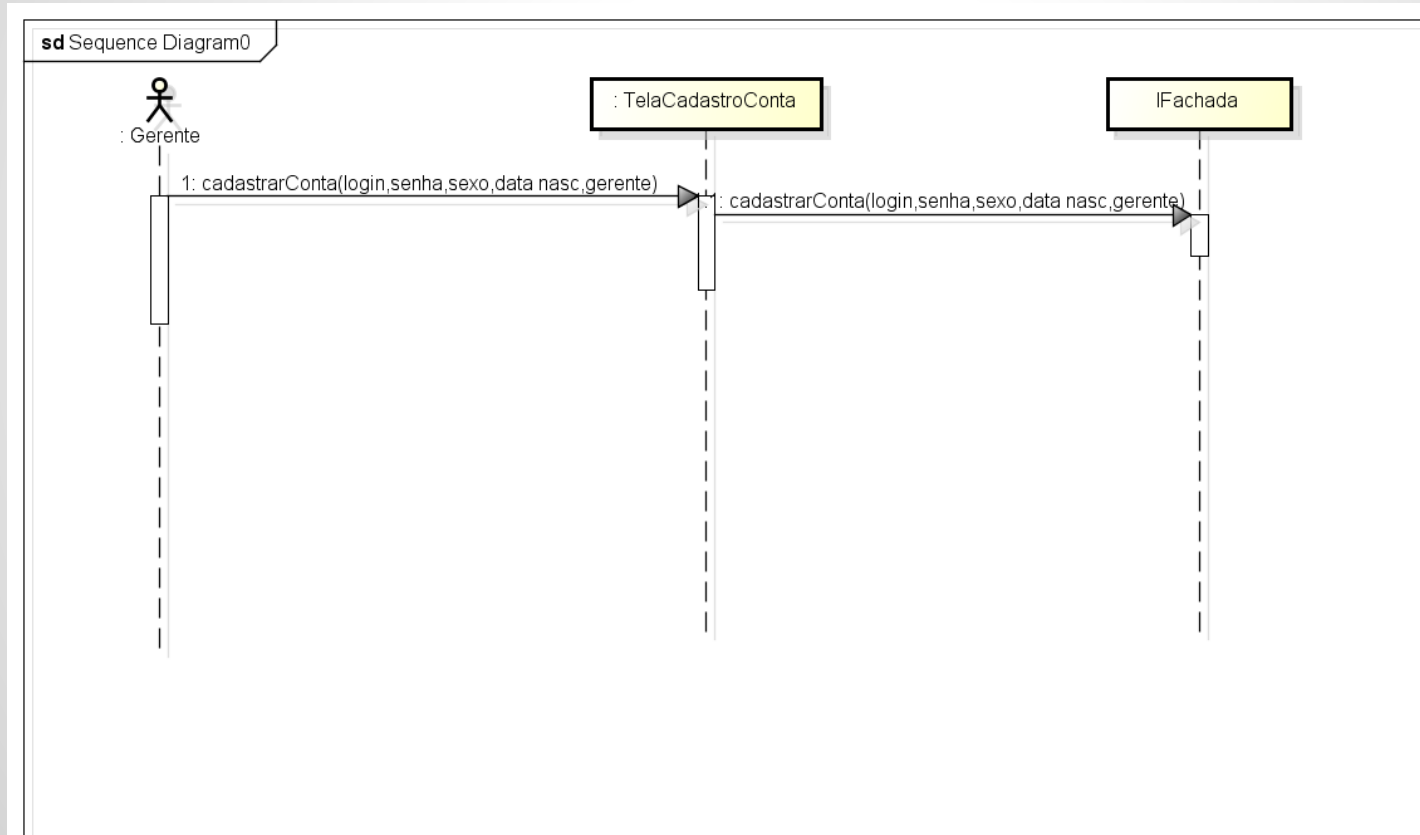

Projeto de Front-end

- Efetuar Treino (classe)

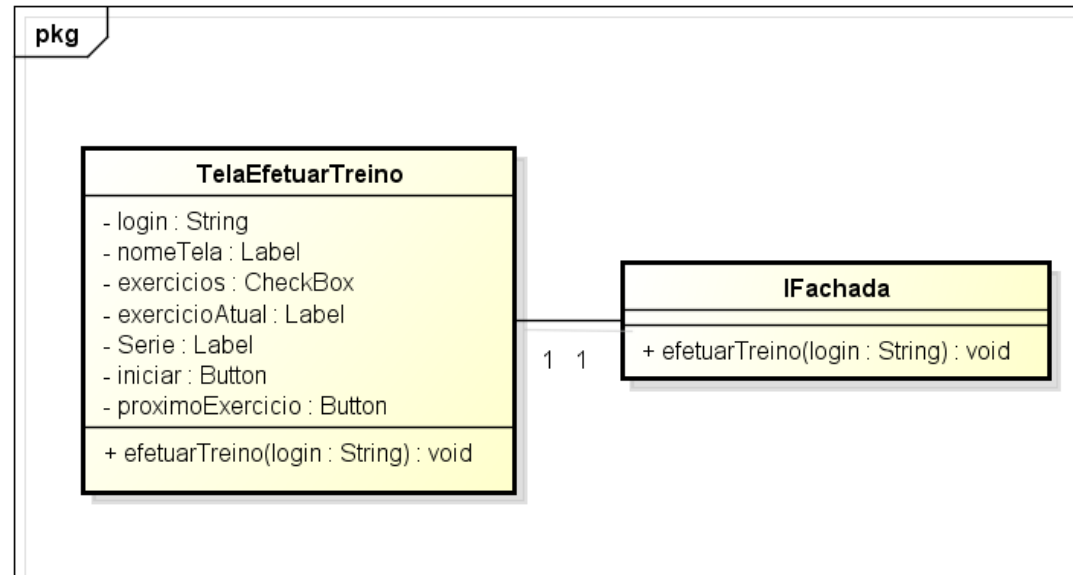
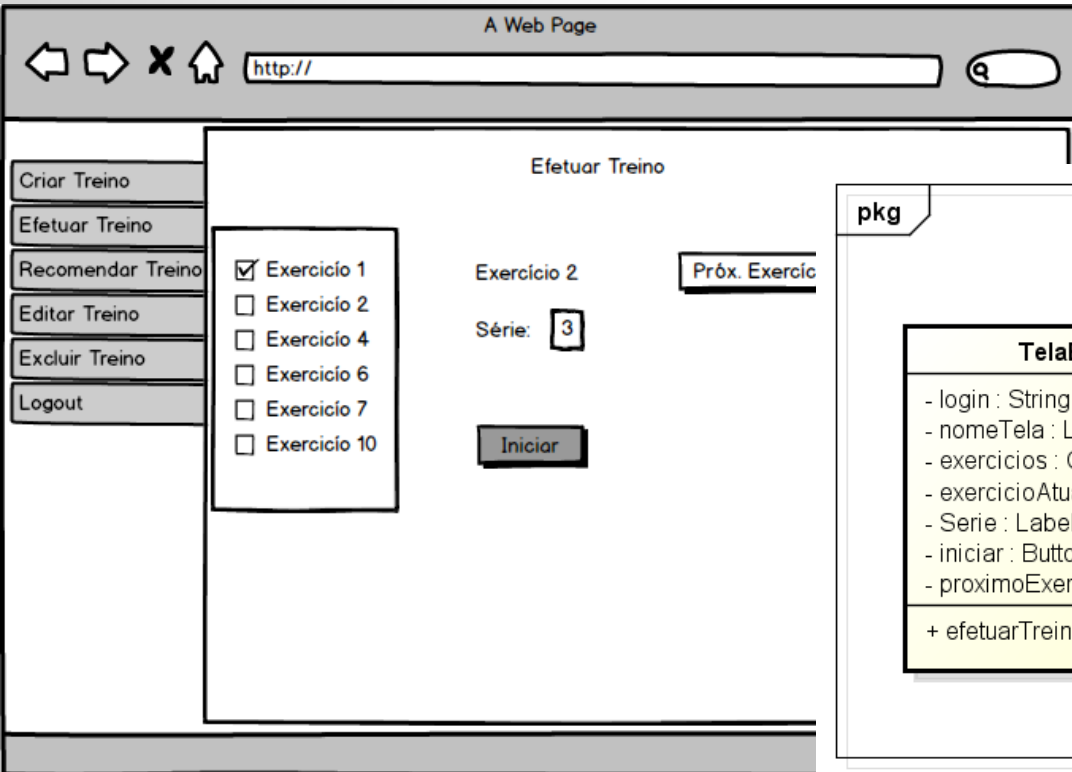

Projeto de Front-end

- Efetuar Treino (sequência)

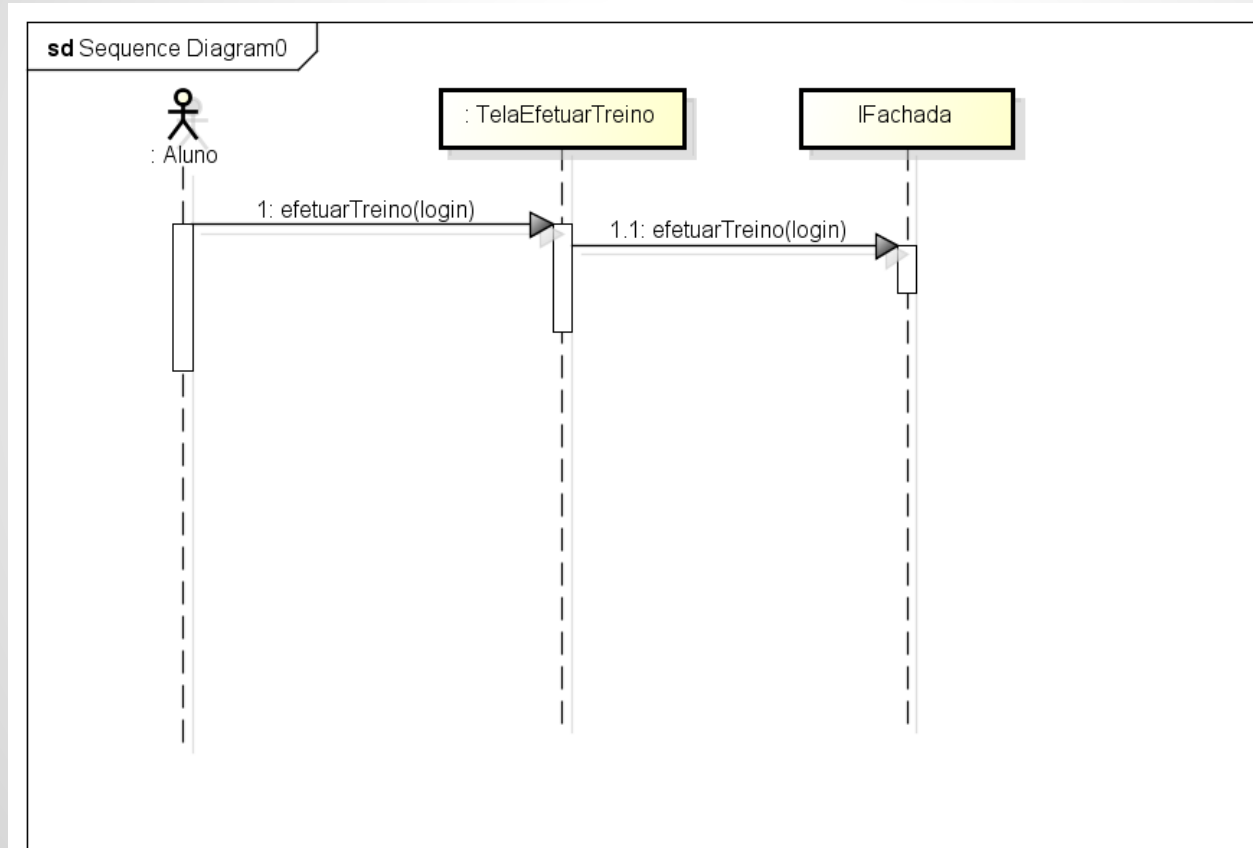

Dúvidas?